

Aleman Area Structure Plan

Location: NW 29-9-21-4

Prepared for: Kevin Aleman, Developer

Prepared by: Wilde Bros. Engineering Ltd.

Approved: June 20, 2019

Bylaw: 19-017

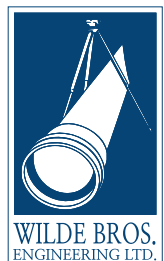

Table of Contents

| | |
|--|----------|
| 1. Introduction | 1 |
| 1.1. Background | 1 |
| 1.2. Purpose and Intent of the Plan | 1 |
| 2. Proposed Subdivision Development | 2 |
| 2.1. Existing Site..... | 2 |
| 2.1.1. Site Conditions..... | 2 |
| 2.1.2. Land Use | 2 |
| 2.2. Developmental Phases..... | 2 |
| 2.2.1. Phase 1 | 2 |
| 2.2.2. Future Phases..... | 2 |
| 3. Transportation and Access | 3 |
| 3.1. Phase 1..... | 3 |
| 3.2. Future Phases | 3 |
| 4. Infrastructure | 4 |
| 4.1. Shallow Underground Utilities | 4 |
| 4.2. Potable Water..... | 4 |
| 4.3. Raw Water (Irrigation) | 4 |
| 4.4. Sanitary Waste Disposal | 5 |
| 4.5. Stormwater Management..... | 5 |
| 5. County Municipal Development Plan Compliance | 6 |
| 5.1. Municipal Reserve | 6 |
| 5.2. Compatibility with Adjacent Land Use | 6 |
| 5.3. Proposed Land Use & Estimated Density..... | 6 |
| 6. Architectural Controls | 7 |

Drawings

- Drawing 1 - Proposed Site Location
- Drawing 2 - Phases / Lot Divisions & Road Layout
- Drawing 3 - Proposed Water Systems
- Drawing 4 - Proposed Irrigation Systems
- Drawing 5 - Existing Topography

Appendices

- Appendix A - Soils Analysis
- Appendix B - Storm Water Management Plan

1. INTRODUCTION

1.1. Background

The Aleman subdivision is located in the Lethbridge County north of the City of Lethbridge limits. It is located entirely within the two quarter sections of SW29 9-21-W4 and NW29 9-21-W4. It extends from Range Road 214A to the undeveloped Government Road Allowance to the west of the sections. The total area of all proposed phases is 21.53 hectares (53.19 acres), broken down into 3.2 hectares (8.20 acres) for Phase 1, and 18.33 hectares (44.99 acres) for future phases. See Drawing 2 for the lot layout. Due to the scale of potential development it has been determined that an Area Structure Plan is required. At present, the proposed development is to subdivide a single lot into three and is referred to as 'Phase 1'. The future potential development would see additional existing lots being subdivided and is referred to as the 'Future Phases'.

1.2. Purpose and Intent of the Plan

The purpose of the Aleman Area Structure Plan is to provide a framework for the future residential subdivision and development of the subject property. In keeping with the requirements of the Lethbridge County, this document shall address the following aspects of the development:

- Development phases
- Potential lot sizes and layouts within existing subdivided lots
- Density of development in general
- Transportation planning, including the general location of major transportation routes and utilities, road allowances, and road easements
- Potable water co-op system/tie-in
- Raw water for irrigation, serviced by St. Mary's River Irrigation District (SMRID), and resolution of existing dug-out systems
- Septic field systems
- Storm water management
- Municipal reserves and open space
- Compatibility with adjacent land uses
- Consistency with the Municipal Development Plan and other adopted plans within the City of Lethbridge

2. PROPOSED SUBDIVISION DEVELOPMENT

2.1. Existing Site

2.1.1. Site Conditions

The existing site is a low density grouped country residential area adjacent to the Oldman River Valley, just north of the City of Lethbridge. Overall, the slopes of the existing site are relatively low, and then steepen rapidly at the top of the coulee. Drawing 5 shows the existing grade contours as surveyed. The site is mostly grassed with trees, bushes, and similar vegetation that has been added as part of the existing residential developments. Drawing 1 shows the existing site with Phase 1 delineated.

2.1.2. Land Use

The existing development is zoned to Grouped Country Residential. The site of Phase 1 has a single residence. The site of the Future Phases has an additional eight residences.

2.2. Developmental Phases

The development will take place in phases. The initial phase, or Phase 1, will take place upon approval. The timeline for the Future Phases is undetermined at this time and will likely be completed by other developers. Drawing 2 shows a potential lot layout for all phases with Phase 1 being delineated.

2.2.1. Phase 1

For Phase 1, the developer owns a single 3.32 hectare (8.2 acres) property that would be subdivided into three lots. The new lots would be sized at 1.27 hectares (3.14 acres), 1.19 hectares (3.0 acres), and 0.85 hectares (2.1 acres).

2.2.2. Future Phases

The Future Phases would consist of the subdivision of the existing six lots into smaller parcels. At this point, the Future Phases are strictly conceptual and could be separated into individual phases more suited for future demand. Each lot would be required to be at least 0.81 hectares (2.0 acres) to ensure compliance with the Lethbridge County standards. A potential layout of the subdivided area is included with this plan.

3. TRANSPORTATION AND ACCESS

All phases will continue being accessed via Range Road 214A. Aside from a new approach off of Range Road 214A as part of Phase 1, the existing approaches and accesses will be adequate for the Future Phases. This will help to minimize the impact that the future development will have on Range Road 214A.

3.1. Phase 1

As part of Phase 1, a new access is being proposed to serve the two new lots. The lot with the existing residence (Lot D) will continue to use the same access that it has been. Lots C and E will use a new shared access that will extend from Range Road 214A across the north of Lots C and D to Lot E. Drawing 2 shows the shared access across the north side of Lots C and D.

3.2. Future Phases

At the time of development of the Future Phases, it is proposed that the existing dual accesses south of Phase 1 will be combined into a single access road that would serve proposed Lots F to O and that could potentially become a county road. This will require that the existing power poles running between the two existing access roads be removed and replaced with either underground power or relocated power poles. Future Lot A would share an access with Lot B.

4. INFRASTRUCTURE

4.1. Shallow Underground Utilities

The existing residential lots are serviced with Telus, natural gas, and overhead power. The new lots being proposed as part of Phase 1 will be serviced with the same shallow utilities as the existing lots. The shallow utilities for the Future Phases will be determined at the time of development.

4.2. Potable Water

It is proposed that the new lots in Phase 1 be serviced with potable water from the co-op that is currently serving the adjacent residences. See Drawing 3 for the existing water line. The developer has made arrangements with the Lethbridge County Rural Water Association Ltd. for the two new lots of Phase 1 to each receive a 0.5 gallon per minute service. They have been paid in full and will include the installation of a curb stop at the property line of each lot. It is the responsibility of each lot owner to then supply and install the water line from the curb stop to their residence.

At this point, no arrangements have been made in regard to servicing the Future Phases as the lot layout will not be determined until the time of development.

4.3. Raw Water (Irrigation)

It is proposed that all three lots in Phase 1 be provided with a raw water service. This would be accomplished using the dugout located on the southwest corner of the existing lot (the southwest corner of proposed Lot E). The dugout is currently filled by the SMRID. Currently, the existing residence on proposed Lot D has a 75mm (3") line coming from the dugout that is pressurized during the summer months (approximately May to October). Drawing 4 shows the layout of the proposed irrigation system.

A water co-op will be set up by the developer to represent the three lots created during Phase 1. An annual fee of \$660 would need to be paid by this co-op to the SMRID, which would be divided equally amongst the three lot owners. For the two new lots, the developer will need to acquire two new acre-foot water licenses; one for each new lot. The existing lot already has a water license. Also as part of the agreement with the SMRID, a flow meter would need to be installed to monitor the volume of water used as it is pumped out of the dugout.

A submersible pump would be installed in the dugout and would be provided by the owner of proposed Lot D at the time of development. The same owner would also be responsible for the future operation and electricity charges associated with the pump. As such, an easement would be required across proposed Lot E to the pump in order to allow for maintenance access. The pump will need to be sized properly to ensure that each lot is serviced with an adequate flow and pressure. A new 50mm (2") line would be drilled from the pump at the dugout to the property line separating proposed Lots C and D. This line would be the service line for proposed Lot C. All raw water services will be pressurized during the summer months which are approximately May to October.

At this time, no plans have been made in regard to raw water servicing of the lots in the Future Phases.

4.4. Sanitary Waste Disposal

In all phases (Phase 1 and Future Phases), all lots will require their own independent septic field system. Each system would be required to meet all applicable codes and standards, and the individual lot owner(s) would bare sole responsibility for the costs, installation, and future maintenance of their system.

For Phase 1, soil samples and analysis were performed to determine suitability of the site for septic fields. The corresponding report is included as Appendix A.

4.5. Stormwater Management

The Developer has had a Storm Water Management Plan prepared for the area involved in Phase 1. The details of the storm analysis and the resulting recommendations are found in the document "Kevin Aleman Lethbridge County Development - Storm Water Management Plan" included as Appendix B.

5. COUNTY MUNICIPAL DEVELOPMENT PLAN COMPLIANCE

5.1. Municipal Reserve

For Phase 1, the Developer will pay cash-in-lieu of land at the time of subdivision.

For Future Phases, it will be determined prior to subdivision how the municipal reserve requirements will be met.

5.2. Compatibility with Adjacent Land Use

The type of development being proposed is compatible with the adjacent land use, inasmuch as the current land use is. The development being proposed will increase the density of the area, but not change the type of land use.

5.3. Proposed Land Use & Estimated Density

All lots in all phases will remain zoned as Grouped Country Residential and will consist of single residence lots with a minimum size of no less than 0.81 hectares (2.0 acres).

Based upon an assumed average occupancy of 2.5 people per residence, and an assumed full build out of all phases of 15 residences, the estimated population density of all phases would be:

| Number of Lots (Residences) | Assumed Occupancy per Residence | Net Population | Net Area | Estimated Population Density |
|--------------------------------|------------------------------------|----------------|----------|---------------------------------|
| 15 | 2.5 | 38 | 19.34 ha | 2.0 people/ha |

6. ARCHITECTURAL CONTROLS

The Developer will require that Architectural Controls be followed for the development. The Architectural Controls will regulate items such as:

- All residences shall be constructed on site. No 'ready-to-move' structures shall be permitted.
- All residences shall be no less than 1500 ft² (139.35 m²).
- Exterior materials shall be approved 'earth tone' colors only.

The Architectural Controls for the development shall form a separate document which the Developer will make available upon request.

Drawings

Drawing 1 - Proposed Site Location

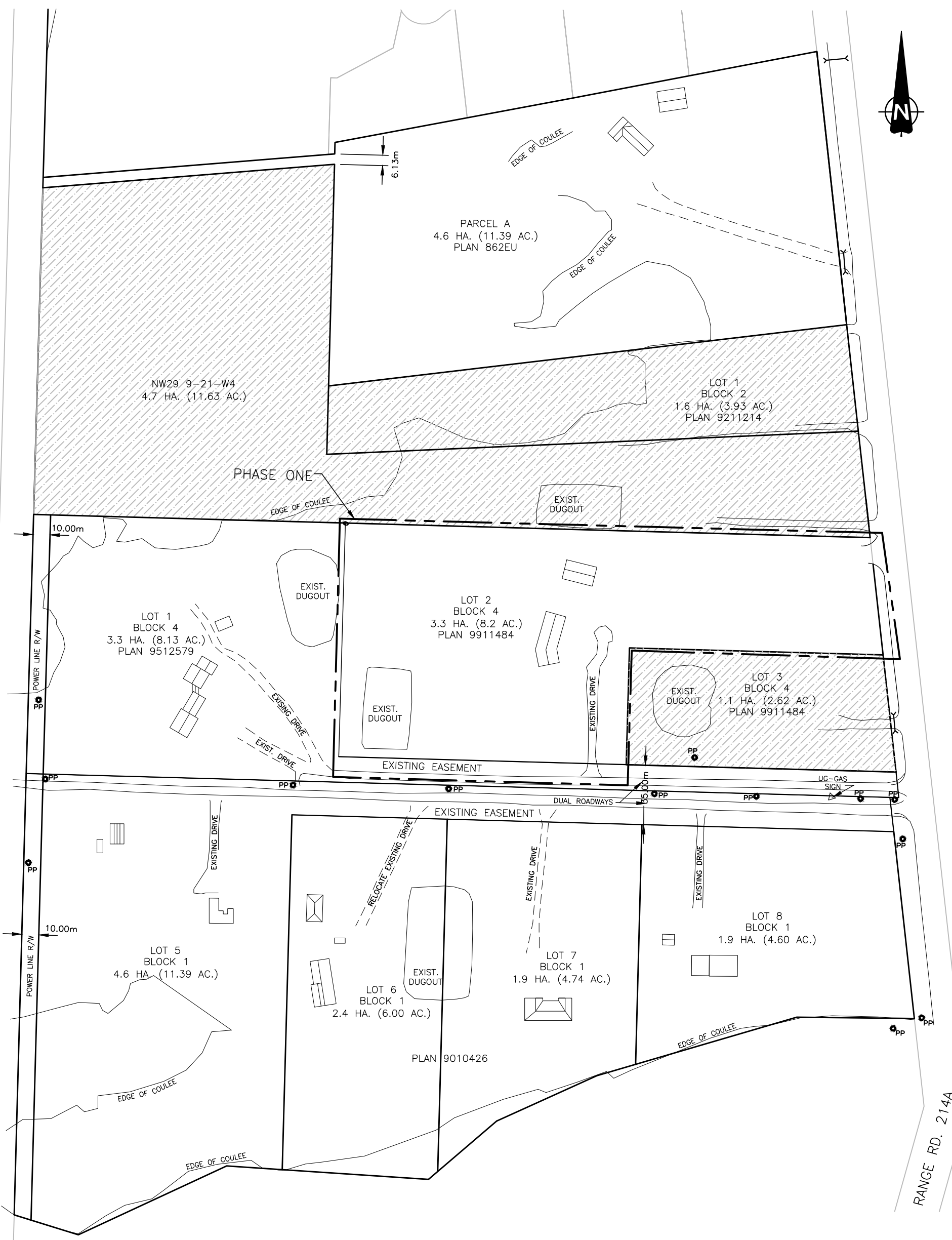

LINE LEGEND:

- EXISTING PROPERTY LINES —————
- EXTENT OF PHASE ONE - - - - -

| ISSUE | DATE | REVISION DESCRIPTION |
|-------|-----------|----------------------|
| 1 | 13SEPT'18 | ISSUED FOR REVIEW |

LEGEND / NOTES

- CONTRACTOR IS RESPONSIBLE FOR VERIFYING THE DEPTH OF SERVICES PRIOR TO CONSTRUCTION.
- ALL UNDERGROUND UTILITIES, INCLUDING GAS, OIL, TELUS, ELECTRICAL, MUNICIPAL WATER, ETC., AS SHOWN ON THIS PLAN, ARE BASED ON INFORMATION RECEIVED FROM THE RESPECTIVE AUTHORITIES. NO RESPONSIBILITY IS IMPLIED OR ASSUMED BY THE ENGINEER AS TO LOCATION, OR OMISSIONS. THE CONTRACTOR MUST CONTACT THE VARIOUS UTILITIES FOR ON-SITE INFORMATION AS TO ACTUAL LINE LOCATIONS PRIOR TO STARTING CONSTRUCTION.
- IT IS THE LANDSCAPER'S RESPONSIBILITY TO ENSURE THAT RUNOFF FOLLOWS THE RECOMMENDED DRAINAGE PATHS AND NO STANDING WATER OCCURS NEAR THE RESIDENCE.
- STORM SEWER LOCATION MAY CHANGE BASED ON THE LOCATION OF EXISTING UNDERGROUND UTILITIES.

WILDE BROTHERS ENGINEERING LTD.
 Welling, Alberta
 PERMIT TO PRACTICE
 P08438

LEGEND:

- CULVERT
- BUILDINGS
- EXISTING LOTS TOO SMALL TO SUBDIVIDE OR TOO FULL OF COULEE LAND.
- POWER POLE: LOCATION APPROX.

WILDE BROS. ENGINEERING LTD.
 Welling, Alberta
KEVIN ALEMAN
PROPOSED SITE LOCATION

| | |
|-------------|---------------|
| DESIGNED: | DJW |
| DRAWN: | J.L.J. |
| SCALE: | 1 : 2250 |
| DATE: | JULY 26, 2018 |
| CHECKED: | DJW |
| JOB: | 9918-07 |
| DIMENSIONS: | METRES |
| DRAWING No: | 1 |

Drawing 2 - Phases / Lot Divisions & Road Layout



LINE LEGEND:
 EXISTING PROPERTY LINES ———
 EXTENT OF PHASE ONE - - - - -
 POTENTIAL PROPERTY LINES - · - · -

| ISSUE | DATE | REVISION DESCRIPTION |
|-------|----------|----------------------|
| 3 | 29OCT'18 | ISSUED FOR REVIEW |
| 2 | 21SEP'18 | ISSUED FOR REVIEW |
| 1 | 13SEP'18 | ISSUED FOR REVIEW |

LEGEND / NOTES

- CONTRACTOR IS RESPONSIBLE FOR VERIFYING THE DEPTH OF SERVICES PRIOR TO CONSTRUCTION.
- ALL UNDERGROUND UTILITIES, INCLUDING GAS, OIL, TELUS, ELECTRICAL, MUNICIPAL WATER, ETC., AS SHOWN ON THIS PLAN, ARE BASED ON INFORMATION RECEIVED FROM THE RESPECTIVE AUTHORITIES. NO RESPONSIBILITY IS IMPLIED OR ASSUMED BY THE ENGINEER AS TO LOCATION, OR OMISSIONS. THE CONTRACTOR MUST CONTACT THE VARIOUS UTILITIES FOR ON-SITE INFORMATION AS TO ACTUAL LINE LOCATIONS PRIOR TO STARTING CONSTRUCTION.
- IT IS THE LANDSCAPER'S RESPONSIBILITY TO ENSURE THAT RUNOFF FOLLOWS THE RECOMMENDED DRAINAGE PATHS AND NO STANDING WATER OCCURS NEAR THE RESIDENCE.
- STORM SEWER LOCATION MAY CHANGE BASED ON THE LOCATION OF EXISTING UNDERGROUND UTILITIES.

WILDE BROTHERS
 ENGINEERING LTD.
 PERMIT TO PRACTICE
 P08438

LEGEND:

- CULVERT
- BUILDINGS
- EXISTING LOTS TOO SMALL TO SUBDIVIDE OR TOO FULL OF COULEE LAND.
- POWER POLE: LOCATION APPROX. THOSE IN THE CENTRE OF THE EXISTING EASEMENT WILL BE RELOCATED.

WILDE BROS. ENGINEERING LTD.
 Welling, Alberta

KEVIN ALEMAN

PROPOSED DEVELOPMENTAL PHASES / LOT DIVISIONS & ROAD LAYOUT

| | |
|-------------|---------------|
| DESIGNED: | DJW |
| DRAWN: | J.L.J. |
| SCALE: | 1 : 2250 |
| DATE: | JULY 26, 2018 |
| CHECKED: | DJW |
| JOB: | 9918-07 |
| DIMENSIONS: | METRES |
| DRAWING No: | 2 |

Drawing 3 - Proposed Water Systems

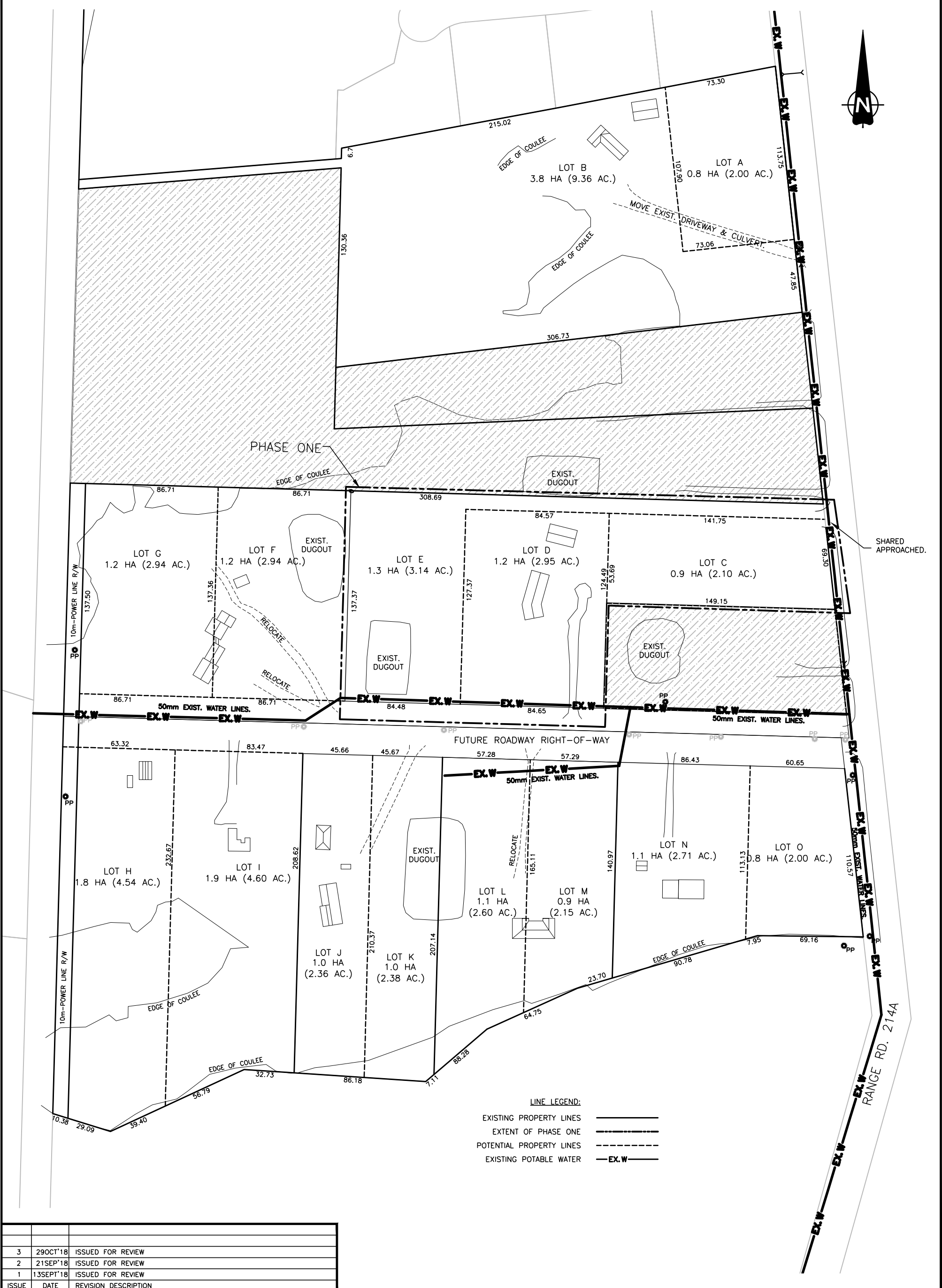

LINE LEGEND:
 ——— EXISTING PROPERTY LINES
 - - - - - EXTENT OF PHASE ONE
 - - - - - POTENTIAL PROPERTY LINES
 — EX.W — EXISTING POTABLE WATER

| ISSUE | DATE | REVISION DESCRIPTION |
|-------|----------|----------------------|
| 3 | 29OCT'18 | ISSUED FOR REVIEW |
| 2 | 21SEP'18 | ISSUED FOR REVIEW |
| 1 | 13SEP'18 | ISSUED FOR REVIEW |

LEGEND / NOTES

- CONTRACTOR IS RESPONSIBLE FOR VERIFYING THE DEPTH OF SERVICES PRIOR TO CONSTRUCTION.
- ALL UNDERGROUND UTILITIES, INCLUDING GAS, OIL, TELUS, ELECTRICAL, MUNICIPAL WATER, ETC., AS SHOWN ON THIS PLAN, ARE BASED ON INFORMATION RECEIVED FROM THE RESPECTIVE AUTHORITIES. NO RESPONSIBILITY IS IMPLIED OR ASSUMED BY THE ENGINEER AS TO LOCATION, OR OMISSIONS. THE CONTRACTOR MUST CONTACT THE VARIOUS UTILITIES FOR ON-SITE INFORMATION AS TO ACTUAL LINE LOCATIONS PRIOR TO STARTING CONSTRUCTION.
- IT IS THE LANDSCAPER'S RESPONSIBILITY TO ENSURE THAT RUNOFF FOLLOWS THE RECOMMENDED DRAINAGE PATHS AND NO STANDING WATER OCCURS NEAR THE RESIDENCE.
- STORM SEWER LOCATION MAY CHANGE BASED ON THE LOCATION OF EXISTING UNDERGROUND UTILITIES.

WILDE BROTHERS
 ENGINEERING LTD.
 PERMIT TO PRACTICE
 P08438

LEGEND:

- CULVERT
- BUILDINGS
- EXISTING LOTS TOO SMALL TO SUBDIVIDE OR TOO FULL OF COULEE LAND.
- POWER POLE: LOCATION APPROX. THOSE IN THE CENTRE OF THE EXISTING EASEMENT WILL BE RELOCATED.

WILDE BROS. ENGINEERING LTD.
 Welling, Alberta

KEVIN ALEMAN

**POTENTIAL SUBDIVISION LAYOUT
 PROPOSED WATER SYSTEMS**

| | |
|-------------|---------------|
| DESIGNED: | DJW |
| DRAWN: | J.L.J. |
| SCALE: | 1 : 2250 |
| DATE: | JULY 26, 2018 |
| CHECKED: | DJW |
| JOB: | 9918-07 |
| DIMENSIONS: | METRES |
| DRAWING No: | 3 |

Drawing 4 - Proposed Irrigation Systems

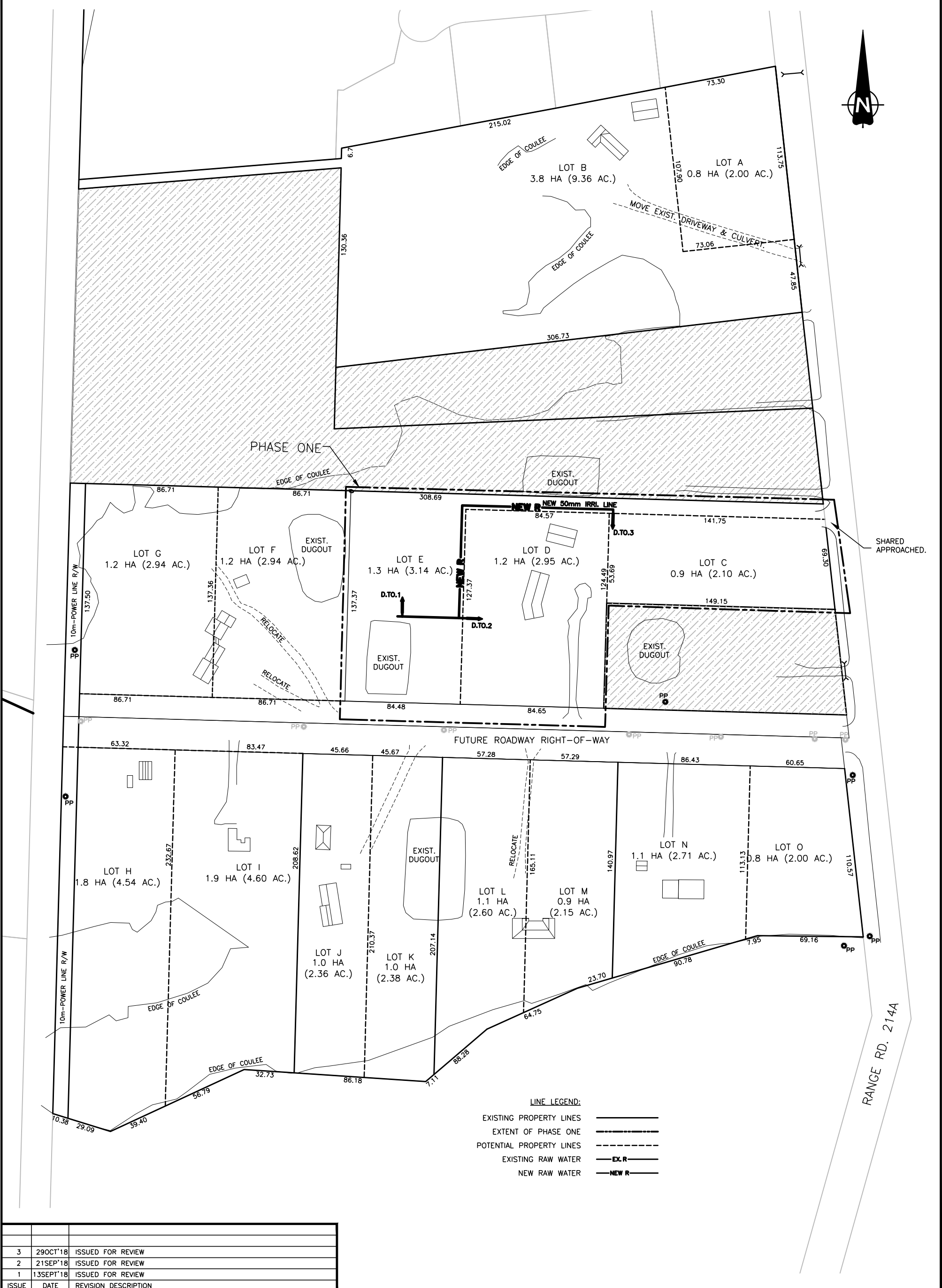

LINE LEGEND:

| | |
|--------------------------|-----------|
| EXISTING PROPERTY LINES | ————— |
| EXTENT OF PHASE ONE | ————— |
| POTENTIAL PROPERTY LINES | - - - - - |
| EXISTING RAW WATER | — EX. R — |
| NEW RAW WATER | — NEW R — |

| ISSUE | DATE | REVISION DESCRIPTION |
|-------|-----------|----------------------|
| 3 | 29OCT'18 | ISSUED FOR REVIEW |
| 2 | 21SEP'18 | ISSUED FOR REVIEW |
| 1 | 13SEPT'18 | ISSUED FOR REVIEW |

LEGEND / NOTES

- CONTRACTOR IS RESPONSIBLE FOR VERIFYING THE DEPTH OF SERVICES PRIOR TO CONSTRUCTION.
- ALL UNDERGROUND UTILITIES, INCLUDING GAS, OIL, TELUS, ELECTRICAL, MUNICIPAL WATER, ETC., AS SHOWN ON THIS PLAN, ARE BASED ON INFORMATION RECEIVED FROM THE RESPECTIVE AUTHORITIES. NO RESPONSIBILITY IS IMPLIED OR ASSUMED BY THE ENGINEER AS TO LOCATION, OR OMISSIONS. THE CONTRACTOR MUST CONTACT THE VARIOUS UTILITIES FOR ON-SITE INFORMATION AS TO ACTUAL LINE LOCATIONS PRIOR TO STARTING CONSTRUCTION.
- IT IS THE LANDSCAPER'S RESPONSIBILITY TO ENSURE THAT RUNOFF FOLLOWS THE RECOMMENDED DRAINAGE PATHS AND NO STANDING WATER OCCURS NEAR THE RESIDENCE.
- STORM SEWER LOCATION MAY CHANGE BASED ON THE LOCATION OF EXISTING UNDERGROUND UTILITIES.

WILDE BROTHERS
ENGINEERING LTD.
PERMIT TO PRACTICE
P08438

LEGEND:

| | | | |
|--|--|--|--|
| | CULVERT | | POWER POLE: LOCATION APPROX. THOSE IN THE CENTRE OF THE EXISTING EASEMENT WILL BE RELOCATED. |
| | BUILDINGS | | DOMESTIC TURNOUT. |
| | EXISTING LOTS TOO SMALL TO SUBDIVIDE OR TOO FULL OF COULEE LAND. | | |

| | |
|---|----------------------|
| WILDE BROS. ENGINEERING LTD. Welling, Alberta | DESIGNED: DJW |
| | DRAWN: J.L.J. |
| KEVIN ALEMAN | SCALE: 1 : 2250 |
| POTENTIAL SUBDIVISION LAYOUT PROPOSED IRRIGATION SYSTEMS | DATE: JULY 26, 2018 |
| | CHECKED: DJW |
| | JOB: 9918-07 |
| | DIMENSIONS: METRES |
| | DRAWING No: 4 |

Drawing 5 - Existing Topography

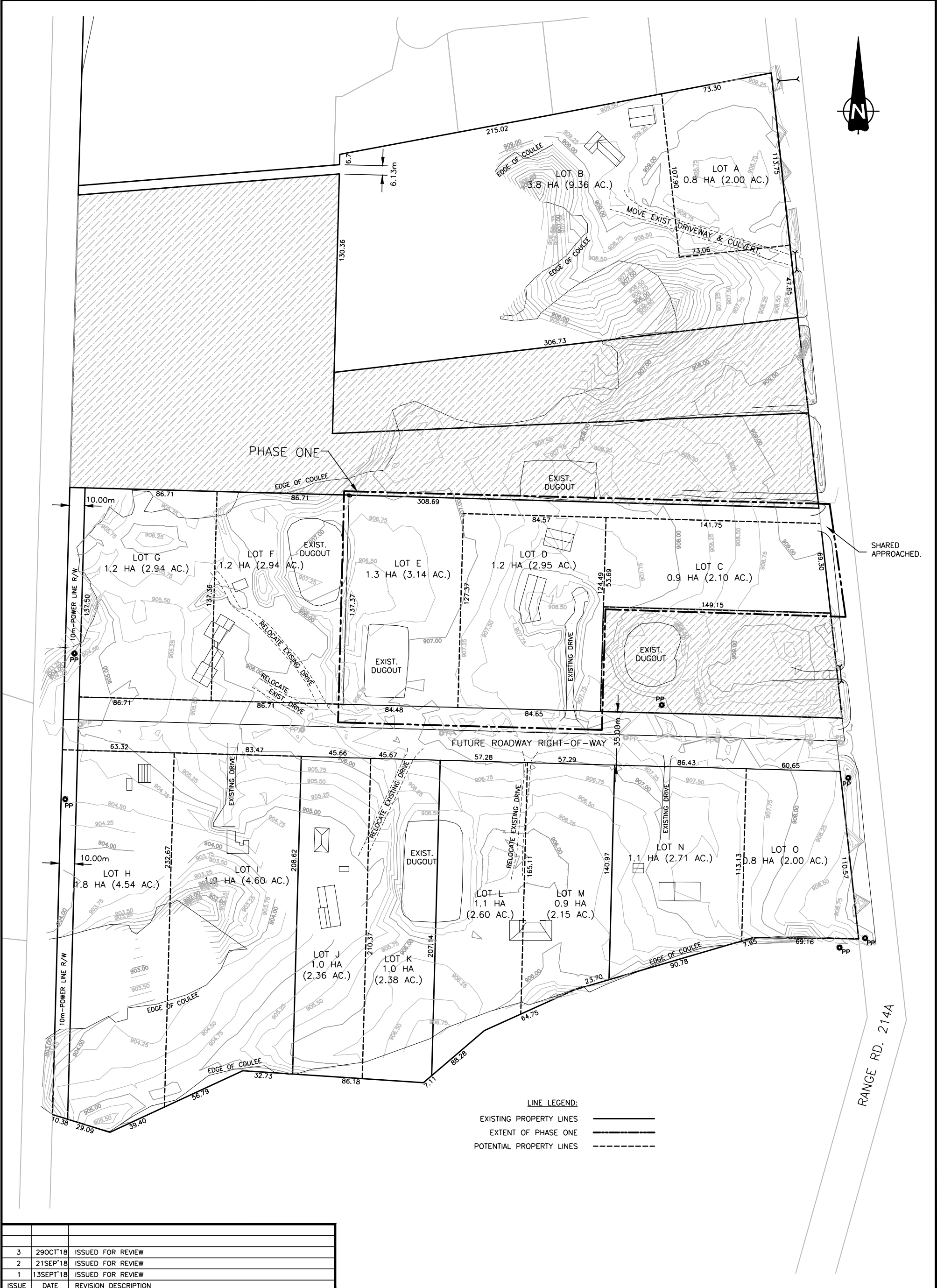

LINE LEGEND:

| | |
|--------------------------|-----------|
| EXISTING PROPERTY LINES | ————— |
| EXTENT OF PHASE ONE | ————— |
| POTENTIAL PROPERTY LINES | - - - - - |

| ISSUE | DATE | REVISION DESCRIPTION |
|-------|-----------|----------------------|
| 3 | 29OCT'18 | ISSUED FOR REVIEW |
| 2 | 21SEP'18 | ISSUED FOR REVIEW |
| 1 | 13SEPT'18 | ISSUED FOR REVIEW |

LEGEND / NOTES

- CONTRACTOR IS RESPONSIBLE FOR VERIFYING THE DEPTH OF SERVICES PRIOR TO CONSTRUCTION.
- ALL UNDERGROUND UTILITIES, INCLUDING GAS, OIL, TELUS, ELECTRICAL, MUNICIPAL WATER, ETC., AS SHOWN ON THIS PLAN, ARE BASED ON INFORMATION RECEIVED FROM THE RESPECTIVE AUTHORITIES. NO RESPONSIBILITY IS IMPLIED OR ASSUMED BY THE ENGINEER AS TO LOCATION, OR OMISSIONS. THE CONTRACTOR MUST CONTACT THE VARIOUS UTILITIES FOR ON-SITE INFORMATION AS TO ACTUAL LINE LOCATIONS PRIOR TO STARTING CONSTRUCTION.
- IT IS THE LANDSCAPER'S RESPONSIBILITY TO ENSURE THAT RUNOFF FOLLOWS THE RECOMMENDED DRAINAGE PATHS AND NO STANDING WATER OCCURS NEAR THE RESIDENCE.
- STORM SEWER LOCATION MAY CHANGE BASED ON THE LOCATION OF EXISTING UNDERGROUND UTILITIES.

WILDE BROTHERS
ENGINEERING LTD.
PERMIT TO PRACTICE
P08438

LEGEND:

| | | | |
|--|--|--|--|
| | CULVERT | | POWER POLE: LOCATION APPROX. THOSE IN THE CENTRE OF THE EXISTING EASEMENT WILL BE RELOCATED. |
| | BUILDINGS | | |
| | EXISTING LOTS TOO SMALL TO SUBDIVIDE OR TOO FULL OF COULEE LAND. | | |

WILDE BROS. ENGINEERING LTD.
Welling, Alberta

KEVIN ALEMAN

POTENTIAL SUBDIVISION LAYOUT
EXISTING TOPOGRAPHY

| | |
|-------------|---------------|
| DESIGNED: | DJW |
| DRAWN: | J.L.J. |
| SCALE: | 1 : 2250 |
| DATE: | JULY 26, 2018 |
| CHECKED: | DJW |
| JOB: | 9918-07 |
| DIMENSIONS: | METRES |
| DRAWING No: | 5 |

Appendices

Appendix A - Soils Analysis



Down To Earth Labs Inc.

The Science of Higher Yields

Mr. Rooter Plumbing
16-94044 RR 214A
Lethbridge, Alberta T1J 5R5

Report #: 63675
Report Date: 11/22/2018
Received: 11/20/2018
Completed: 11/22/2018
Test Done: ST

Project :
Aleman Subdivision

3510 6th Ave North
Lethbridge, AB T1H 5C3
403-328-1133
www.downtoearthlabs.com
info@downtoearthlabs.com

| Analyte | Units | Limit | Sample ID: | Sample ID: | Sample ID: | Sample ID: | Sample ID: |
|--------------|-------|-------|------------------|------------------|------------------|------------------|------------------|
| | | | 1811200023 | 1811200024 | 1811200025 | 1811200026 | 1811200027 |
| | | | Cust. Sample ID: | Cust. Sample ID: | Cust. Sample ID: | Cust. Sample ID: | Cust. Sample ID: |
| | | | West Lot West | West Lot West | West Lot East | West Lot East | East Lot East |
| | | | 16-36 | 36-60 | 20-60 | 60" | 20-60 |
| Sand | % | 0.1 | 42.5 | 16.5 | 20.5 | 16.6 | 22.5 |
| Silt | % | 0.1 | 33.6 | 53.5 | 49.5 | 29.4 | 47.5 |
| Clay | % | 0.1 | 23.9 | 30.0 | 30.0 | 54.0 | 30.0 |
| Soil Texture | - | 1 | Loam | Silty Clay Loam | Clay Loam | Clay | Clay Loam |

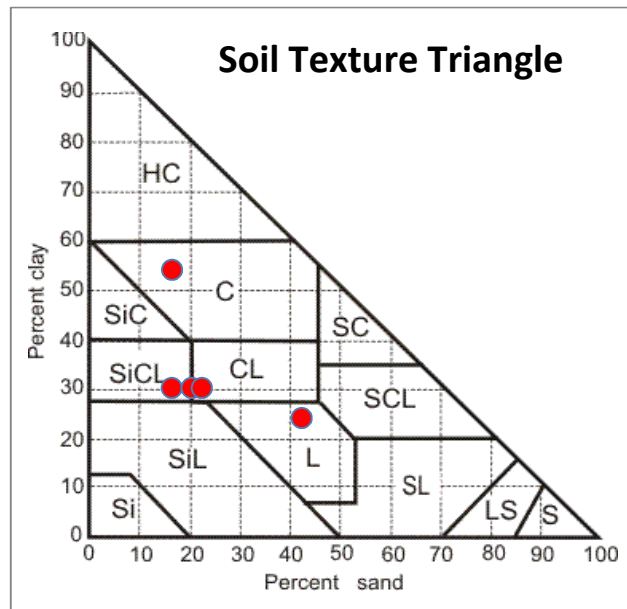



Down To Earth Labs Inc.

The Science of Higher Yields

Mr. Rooter Plumbing
16-94044 RR 214A
Lethbridge, Alberta T1J 5R5

Report #: 63675
Report Date: 11/22/2018
Received: 11/20/2018
Completed: 11/22/2018
Test Done: ST

Project :
Aleman Subdivision

3510 6th Ave North
Lethbridge, AB T1H 5C3
403-328-1133
www.downtoearthlabs.com
info@downtoearthlabs.com

Sample ID: 1811200028 1811200029
Cust. Sample ID: East Lot East East Lot West

| Analyte | Units | Limit | 60" | 24" |
|--------------|-------|-------|------|-----------|
| Sand | % | 0.1 | 44.5 | 36.5 |
| Silt | % | 0.1 | 29.5 | 35.5 |
| Clay | % | 0.1 | 26.0 | 28.0 |
| Soil Texture | - | 1 | Loam | Clay Loam |

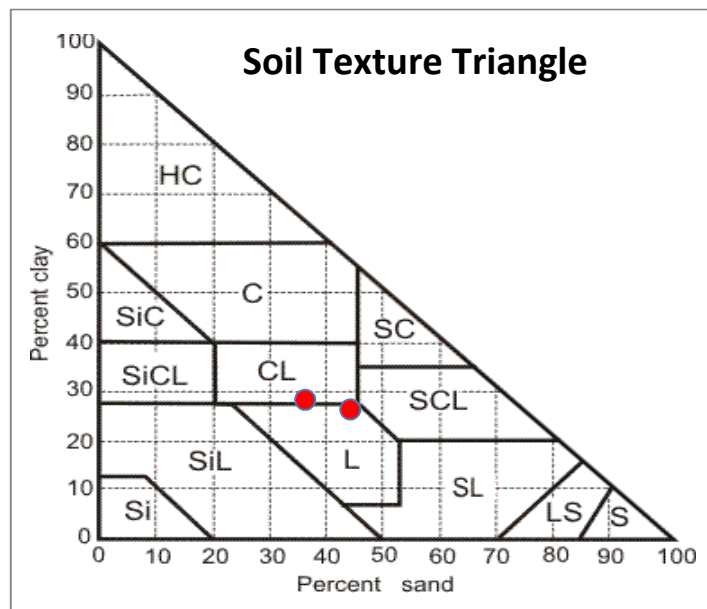

Raygan Boyce - Chemist

Appendix B - Storm Water Management Plan

Aleman Development

Storm Water Management Plan

Location: NW 29-9-21-4

Prepared for: Kevin Aleman, Developer

Prepared by: Wilde Bros. Engineering Ltd.

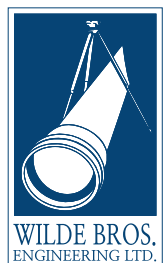

Table of Contents

- 1. Introduction1
- 2. Pre-Development Conditions1
 - 2.1. *Site & Topography*1
- 3. Post-Development Conditions1
 - 3.1. *Proposed Site Development*1
- 4. Storm Model.....1
 - 4.1. *Pre-Development Model*2
 - 4.2. *Post-Development Model*2
 - 4.3. *Results*.....3
- 5. Proposed Storm Water Management3

1. INTRODUCTION

The Developer is proposing a subdivision of an existing lot in the Lethbridge County. As part of the development it is required that a Storm Water Management plan be prepared for review. Wilde Brothers Engineering was contracted to perform a site survey and prepare the plan. The County requires that all new developments be able to manage the anticipated increase in storm water runoff by restricting post-development flows to a pre-development peak flow and storing the resulting difference.

2. PRE-DEVELOPMENT CONDITIONS

2.1. Site & Topography

The site of the proposed development is currently a single 3.3 hectare (8.2 acre) lot on NW 29-9-21-4. Situated at the top of the Oldman River coulee, the land has a relatively flat slope down toward the coulee. There is a single residence on the existing property with a detached shop. The majority of the site is grassed with the exception of the driveway to the existing residence and shop.

3. POST-DEVELOPMENT CONDITIONS

3.1. Proposed Site Development

The development being proposed would see the existing single lot being subdivided into three lots. The existing topography will remain unaltered, with the exception of an access road for the new lot furthest west. Any residences will also need to be built elevated and away from low areas with grading such that runoff will be directed away from the foundation.

4. STORM MODEL

In order to estimate the potential increase in storm water runoff that would result from the proposed development, a computer model was created to simulate pre-development and post-development conditions. The Lethbridge County engineering standards stipulate that the storm water system be designed such that a 'net-zero' impact is achieved (runoff rates for a 24 hour duration, 1:100 year post-development design storm will not exceed rates for the same design storm under pre-development conditions). The primary difference between the pre- and post-development conditions is the percentage of impervious area.

Table 1: Storm Model Used

| Model | Catchment Areas | Infiltration Model | Storm Systems | Storm(s) Modeled |
|-----------------|--|--|---------------|---|
| Pre-Development | 3.3 hectare site / 1 residential lot / 7.9% impervious area / 1.9% average slope | Green Ampt with typical parameters based on soil analysis performed on site. | Major only | <ul style="list-style-type: none"> 1-in-100 year 24 hour Modified Chicago event, created using parameters from the City of Lethbridge engineering standards. |

Aleman Development Storm Water Management Plan

March 19, 2019

| Model | Catchment Areas | Infiltration Model | Storm Systems | Storm(s) Modeled |
|------------------|--|--|---------------|---|
| Post-Development | 3.3 hectare site / 3 residential lots / 15.4% impervious area / 1.9% average slope | Green Ampt with typical parameters based on soil analysis performed on site. | Major only | <ul style="list-style-type: none"> 1-in-100 year 24 hour Modified Chicago event, created using parameters from the City of Lethbridge engineering standards. |

4.1. Pre-Development Model

The pre-development site was modeled using the parameters shown in Table 1. The average overall slope of the site was 1.9% toward the coulee to the west. Based on the existing residence, shop, and shale driveway, the impervious area was calculated at 7.9% of the total site. As the site is mostly grass and there are no concrete conveyances (swales, etc.) the model was set to route the runoff of the impervious areas onto the pervious areas.

The storm used for the model was a 1-in-100 year 24 hour Modified Chicago storm that was created using the parameters specified in the City of Lethbridge engineering standards. The pre-development results of the storm model are summarized in Table 2.

Table 2: Pre-Development Model Results

| | | 1-in-100 Year, 24 Hour Storm Event | | |
|-------------------|---------|------------------------------------|------------------------|----------------------|
| Region | Area | Mean Flow Rate | Peak Flow Rate | Total Runoff Volume |
| Pre-Dev Catchment | 3.32 ha | 0.02 m ³ /s | 0.62 m ³ /s | 1,794 m ³ |

4.2. Post-Development Model

The post-development site was also modeled using the parameters shown in Table 1. The average slope of the post-development site was kept the same as the pre-development site as the development is not proposing that the lots be regraded. The impervious area of the post-development site was estimated at 15.4% based on two new residences of an arbitrary 232m² (2500ft²) and access roads to each.

The storm used for the model was the same 1-in-100 year 24 hour Modified Chicago storm that was created and used for the pre-development scenario. The results of the post-development model are summarized in Table 3.

Table 3: Post-Development Model Results

| | | 1-in-100 Year, 24 Hour Storm Event | | |
|--------------------|---------|------------------------------------|------------------------|----------------------|
| Region | Area | Mean Flow Rate | Peak Flow Rate | Total Runoff Volume |
| Post-Dev Catchment | 3.32 ha | 0.02 m ³ /s | 0.72 m ³ /s | 1,754 m ³ |

4.3. Results

Based on the pre- and post-development peak runoffs, the post-development will need to be throttled from 0.72m³/s down to 0.62m³/s. It was calculated that this will result in ~140m³ of runoff that will require storage.

5. PROPOSED STORM WATER MANAGEMENT

In order to provide the required detention storage, it is proposed that a detention pond be constructed in the northwest corner of the proposed subdivision, as shown on Drawings SWM-1 & SWM-2. It will be sized such that the difference between the pre- and post-development 1-in-100 year 24 hour storm can be detained without overflowing.

To try and get as much runoff as possible from the site into the pond, it is also proposed that two ditches be constructed between the subdivision and adjacent properties (see Drawing SWM-1). The one would be constructed along the west side of the west proposed lot and would intercept runoff that may have previously collected there and carry it north into the detention pond. The other would be constructed along the north side of the development and would carry runoff from the east into the detention pond.

The pond would have a culvert outlet to the northwest to the coulee. By limiting the size of the culvert, the outflow from the pond can be throttled to the pre-development peak flow rate. This will allow runoff from common storms to pass through, but runoff from a severe storm event will backup into the pond until the flows into the pond are less than the flow out of the pond. In order to control where flooding from the pond would go during a storm greater than the 1-in-100 year 24 hour storm event, an overflow would be constructed in the pond bank at the northwest. This overflow would have a weir elevation of 906.15m, which would allow the overflow to run into the coulee before it would backup onto the adjacent properties. As the pipe and overflow would need to cross a short portion of the adjacent property, the Developer would need to get an easement on the portion of the adjacent property where the overflow and outlet pipe would be. The exact amount of easement will be determined at time of final design and prior to construction.

Y:\99 - MISC PROJECTS\9918\9918-07 KEVIN ALEMAN\STORM ANALYSIS\9918-07 - STORM ANALYSIS - RD.DWG (1) OVERVIEW [PLOTTED ON 16 Jan 2019 - 14:46]

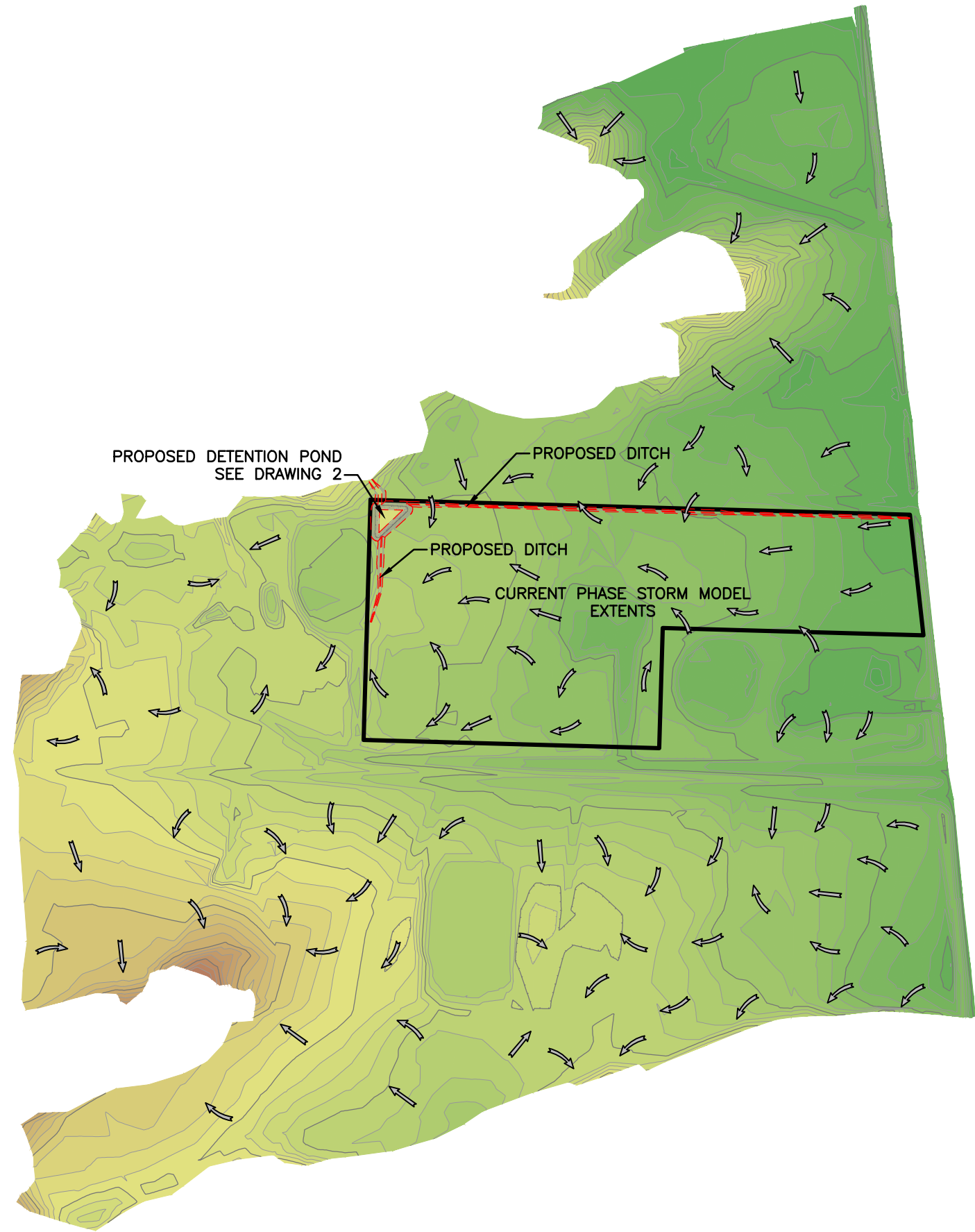

LEGEND / NOTES

- EXISTING FLOW PATHS
- PROPOSED DITCHES & POND

| ISSUE | DATE | REVISION DESCRIPTION |
|-------|----------|----------------------|
| 0 | 11JAN'19 | PRELIMINARY |

WILDE BROTHERS
ENGINEERING LTD.
PERMIT TO PRACTICE
P08438

WILDE BROS. ENGINEERING LTD.
Raymond, Alberta

KEVIN ALEMAN

PROPOSED DEVELOPMENT
EXISTING FLOW PATHS

| | |
|-----------------------|--------------------------|
| DESIGNED: | CHECKED: |
| DRAWN: JPL | JOB: 9918-07 |
| SCALE: 1:3000 | DIMENSIONS: METERS |
| DATE: 11 JANUARY 2019 | DRAWING No: SWM-1 |

Y:\99 - MISC PROJECTS\9918-07 KEVIN ALEMAN\STORM ANALYSIS\9918-07 - STORM ANALYSIS - ROAD (2) POND DETAIL [PLOTTED ON 16 Jan 2019 - 14:46]

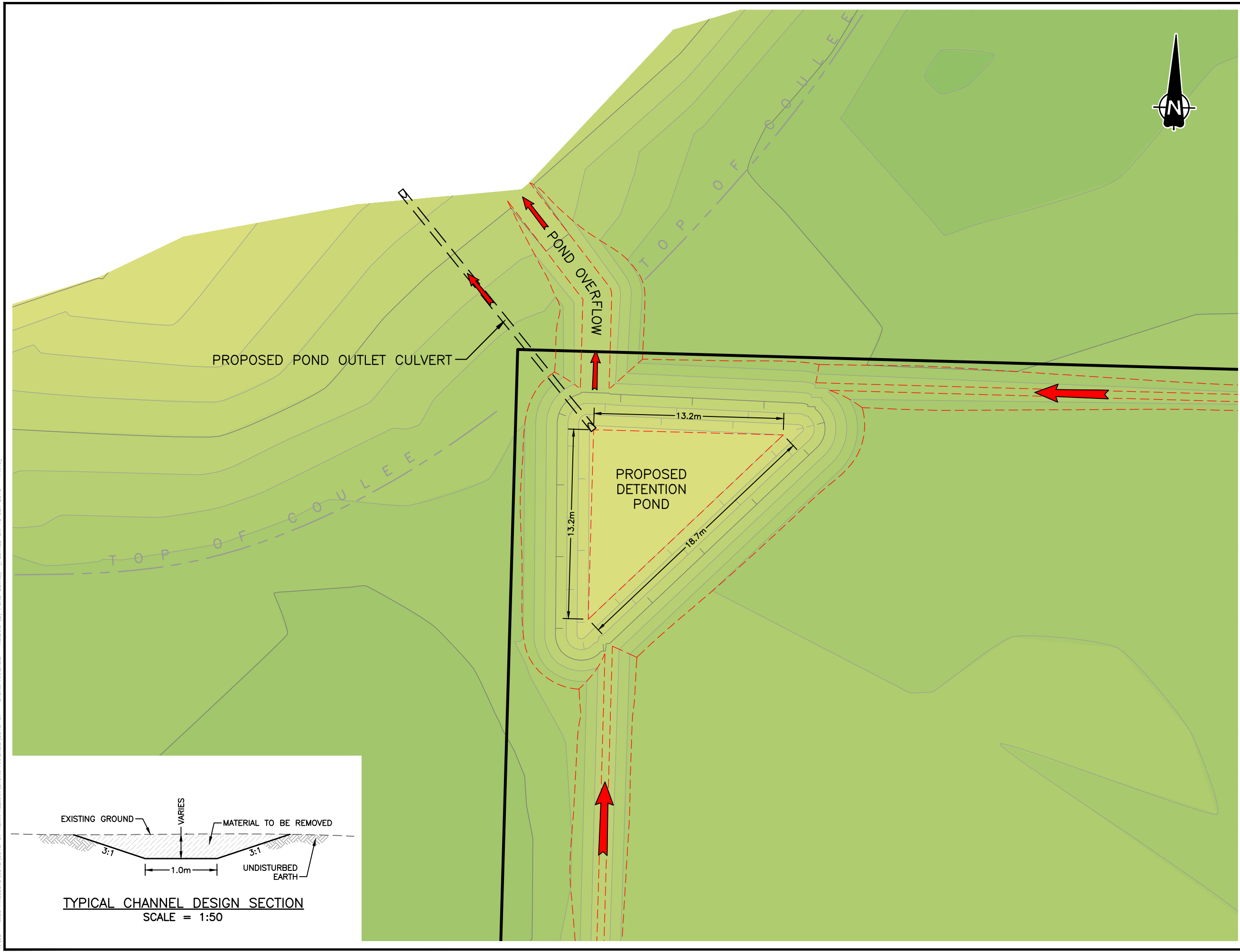

LEGEND / NOTES

CAPTURED RUNOFF FLOW DIRECTION

PROPOSED DITCHES & POND

| ISSUE | DATE | REVISION DESCRIPTION |
|-------|----------|----------------------|
| 0 | 11JAN'19 | PRELIMINARY |

WILDE BROTHERS
ENGINEERING LTD.
PERMIT TO PRACTICE
P08438

WILDE BROS. ENGINEERING LTD.
Raymond, Alberta

KEVIN ALEMAN

PROPOSED DEVELOPMENT
PROPOSED DETENTION POND

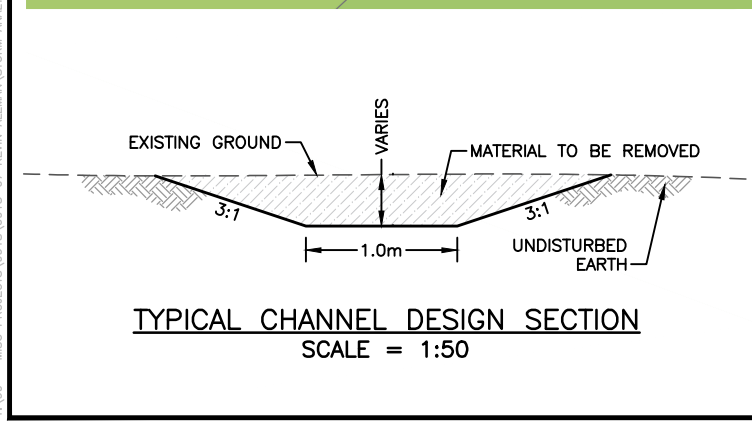

| | |
|-----------------------|--------------------------|
| DESIGNED: DJW | CHECKED: |
| DRAWN: JPL | JOB: 9918-07 |
| SCALE: 1:250 | DIMENSIONS: METERS |
| DATE: 11 JANUARY 2019 | DRAWING No: SWM-2 |